

1983-1984

GRADUATE STUDY  
IN PHYSICS AND ASTRONOMY

The University of Iowa

# Graduate Study in Physics and Astronomy



*Professor James Van Allen, Head of Department*

## *Page*

2	Faculty and Research Staff
4	Advanced Degrees
5	Facilities
6	Research
11	Recent Recipients of the Ph.D. Degree
13	Recent Publications

*The Voyager spacecraft which visited Jupiter and Saturn*



# Faculty and Research Staff

CARLSON, Richard R., Ph.D., Chicago, 1951.

Professor. Experimental low-energy nuclear physics.

CARPENTER, Raymon T., Ph.D., Northwestern, 1962.

Professor. Experimental plasma physics.

D'ANGELO, Nicola, Ph.D., Rome, 1953.

Professor. Experimental plasma physics; experimental space physics.

ENEMARK, Donald D., Ph.D., Iowa, 1970.

Adjunct Associate Professor. Electronics.

FIX, John D., Ph.D., Indiana, 1969.

Professor. Astrophysics.

FRANK, Louis A., Ph.D., Iowa, 1964.

Professor. Experimental space physics.

GOERTZ, Christoph K., Ph.D., Rhodes, 1972.

Professor. Theoretical space physics.

GURNETT, Donald A., Ph.D., Iowa, 1965.

Professor. Experimental space physics.

KLINK, William H., Ph.D., Johns Hopkins, 1964.

Professor. Elementary particle physics; mathematical physics.

KNORR, Georg E., Ph.D., Munich, 1963.

Professor. Theoretical plasma physics.

LASTER, Howard J., Ph.D., Cornell, 1957.

Professor. Cosmic ray astrophysics.

LONNGREN, Karl E., Ph.D., Wisconsin, 1964.

Professor (also Electrical Engineering and Computer Science). Experimental plasma physics.

McCLIMENT, Edward R., Ph.D., Illinois, 1962.

Professor. Elementary particle physics.

MERLINO, Robert L., Ph.D., Maryland, 1980.

Assistant Professor. Experimental plasma physics.

MUTEL, Robert L., Ph.D., Colorado, 1975.

Associate Professor. Radio astronomy.

NEFF, John S., Ph.D., Wisconsin, 1961.

Professor. Observational optical astronomy.

NELSON, Edward B., Ph.D., Columbia, 1949.

Professor Emeritus.

NEWSOM, Charles R., Ph.D., Texas, 1980.

Assistant Professor. Experimental intermediate-energy nuclear physics.

NICHOLSON, Dwight R., Ph.D., California, Berkeley, 1975.

Associate Professor. Theoretical plasma physics.

NORBECK, Edwin, Ph.D., Chicago, 1956.

Professor. Experimental nuclear physics.

PAYNE, Gerald L., Ph.D., California, San Diego, 1967.

Professor. Theoretical nuclear physics; theoretical plasma physics.

POLYZOU, Wayne N., Ph.D., Maryland, 1979.

Assistant Professor. Theoretical nuclear physics.

SAVAGE, William R., Ph.D., Iowa State, 1956.

Professor. Acoustics and experimental solid-state physics.

SCHWEITZER, John W., Ph.D., Cincinnati, 1966.

Professor. Theoretical solid-state physics.

SHAWHAN, Stanley D., Ph.D., Iowa, 1966.

Professor. Observational radio astronomy; experimental space physics.

SPANGLER, Steven R., Ph.D., Iowa, 1975.

Associate Professor. Astrophysics; extragalactic radio astronomy.

STWALLEY, William C., Ph.D., Harvard, 1969.

Professor (also Chemistry). Quantum optics, low-temperature physics, atomic and molecular physics, laser physics.

*Van Allen Hall from the southwest*



VAN ALLEN, James A., Ph.D.,  
Iowa, 1939.  
Professor, Head of Department.  
Experimental space physics;  
astrophysics.

#### Research Scientists

Kent L. Ackerson, Ph.D., Iowa,  
1972.

Space plasma physics.

Roger R. Anderson, Ph.D., Iowa,  
1976.

Interplanetary and  
magnetospheric plasma  
waves.

Wynne Calvert, Ph.D., Colorado,  
1962.

Space plasma waves.

John D. Craven, Ph.D., Iowa,  
1969.

Auroral and magnetospheric  
physics.

Timothy E. Eastman, Ph.D.,  
Alaska, 1979.

Space plasma physics.

Robert R. Shaw, Ph.D., Iowa,  
1975.

Space physics.

#### Associate Research Scientists

Joseph E. Borovsky, Ph.D., Iowa,  
1981.

Numerical simulation of  
plasmas.

Crockett L. Grabbe, Ph.D.,  
California Institute of Technology,  
1977.

Theoretical plasma physics.

William S. Kurth, Ph.D., Iowa,  
1979.

Interplanetary and  
magnetospheric plasma  
waves.

Mary M. Mellott (Hoppe), Ph.D.,  
Washington (St. Louis), 1975.

Space plasma physics.

Bruce A. Randall, Ph.D., Iowa,  
1972.

Magnetospheric physics.

#### Assistant Research Scientists

Cheryl Y. Huang, Ph.D., Iowa,  
1981.

Space physics.

James P. Sheerin, Ph.D.,  
Michigan, 1980.

Theoretical plasma physics.

#### Research Investigator

Ralph L. Fiedler, Ph.D.,  
Minnesota, 1982.

Astrophysics

### Iowa Laser Facility

#### Assistant Research Scientist

Paul D. Kleiber, Ph.D., Colorado,  
1981.

Atomic and molecular physics  
and laser physics.

#### Research Associates

Shawn P. Heneghan, Ph.D.,  
Southern California, 1982.

Low-temperature and  
molecular physics.

Kuo-Kwang Wang, Ph.D.,  
Cincinnati, 1982.

Solid-state physics.

Marjatta Lyyra, Ph.D., Stockholm,  
1979.

Laser spectroscopy.

John T. Bahns, Ph.D., Iowa, 1984.

Laser spectroscopy.



*Professor Christoph Goertz*

*Neutral atoms glow after being struck by electrons in an experimental plasma physics device*

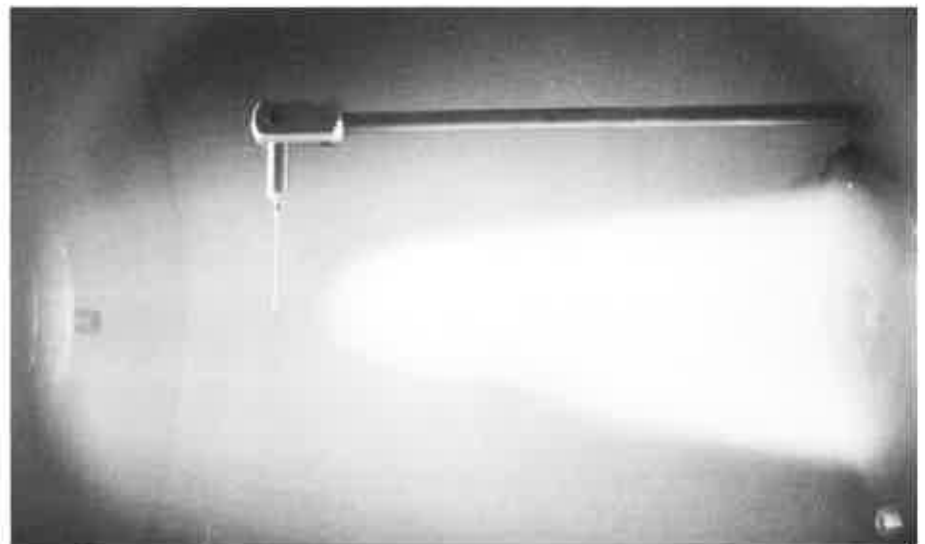

# Advanced Degrees



*Inside the 6-million volt Van de Graaff accelerator*

Two advanced degrees are offered in physics: the Master of Science, with thesis or with critical essay; and the Doctor of Philosophy with a research dissertation. One advanced degree is offered in astronomy: the Master of Science with thesis or with critical essay. A student who wishes to pursue a program in astronomy beyond the M.S. level may qualify for a Doctor of Philosophy degree in physics with specialization and a dissertation in astronomy or astrophysics. An interdepartmental (Ph.D.) program is available in applied mathematical science.

Each graduate student has an individual faculty adviser who oversees the student's academic work and thesis or dissertation research. A typical Ph.D. program requires five years of graduate work.

*Professor Gerald Payne and a graduate student discuss nuclear theory*



# Facilities

Facilities for graduate study in physics and astronomy are located in the 195,000-square-foot Van Allen Hall. This completely air-conditioned building houses an excellent open-stack library, machine shops, laboratories, offices, storerooms, auditoria, darkrooms, classrooms, lecture halls, and seminar rooms. A desk and private study area are provided for each graduate student.

The laboratories are well equipped and the central machine shop is staffed with skilled instrument makers and machinists. There are several electronics and machine shops for the use of advanced students and the research staff.

An IBM 3033 computer, four Prime 850 systems, two Prime 750 systems, three HP 2000 systems, a DEC Vax 11/780, and the associated facilities of the Weeg Computing Center are available for research use by students and staff. The department itself has a DEC Vax 11/780 computer, two UNIVAC computers, two CDC computers, and numerous microcomputers dedicated to specific research programs. Many time-sharing terminals and extensive auxiliary apparatus are provided for student use. Access to major national computing centers is also available.

Major research facilities in physics and astronomy are

- (a) A comprehensive array of low-energy particle accelerators, electronic test equipment, and environmental test chambers and clean rooms, and an optics laboratory for the development, calibration, and proof testing of instruments for space flight.
- (b) A computer-assisted design (CAD) facility.
- (c) A 6-MV Van de Graaff accelerator in a nuclear physics laboratory adjoining Van Allen Hall.

- (d) 24-inch and 12-inch Cassegrain telescopes at the Riverside Astronomical Observatory ten miles south of Iowa City.
- (e) 60-foot and 28-foot radio telescopes located at the North Liberty Radio Observatory 12 miles north of Iowa City (part of the national Very Long Baseline Interferometry network).
- (f) A solid-state laboratory with facilities for magnetic susceptibility, resistivity, Hall effect, and specific heat measurements at low temperatures and facilities for the preparation of experimental materials.
- (g) Several plasma physics laboratories with two large vacuum chambers and a variety of multidipole and triple-plasma devices and associated computer-based diagnostic equipment, used for basic research and the support of various national fusion energy programs.
- (h) An acoustics laboratory for study of the physics of musical instruments.
- (i) The Iowa Laser Facility (physically located in the Chemistry Building) which contains a wide variety of modern laser instrumentation. Several monochromators (with lengths to 3.4 meters), high vacuum molecular beam systems, and low-temperature equipment (including a 110 kG superconducting magnet and a helium dilution refrigerator capable of 0.012 K) are also located in the laboratory.

Advanced astronomy students also conduct research at the National Astronomy and Ionosphere Center at Arecibo, Puerto Rico; the Very Large Array radio telescope near Socorro, New Mexico; the Very Long Baseline Interferometry Network; Haystack Observatory at Westford, Mas-

sachusetts; Kitt Peak National Observatory, near Tucson, Arizona; and the Infrared Telescope Facility, Mauna Kea, Hawaii.

Arrangements are available for student research in nuclear and elementary particle physics at the Fermi National Accelerator Laboratory in Batavia, Illinois, and the Argonne National Laboratory in Argonne, Illinois; in space plasma physics at the Los Alamos National Laboratory in Los Alamos, New Mexico; and in ionospheric plasma physics at the National Astronomy and Ionosphere Center near Arecibo, Puerto Rico.

Supercomputers are accessed by telephone at the National Magnetic Fusion Energy Computing Center in Livermore, California, the Los Alamos National Laboratory, and the National Center for Atmospheric Research in Boulder, Colorado. The Los Alamos facility is primarily used by nuclear theory students, while the Boulder and Livermore facilities are primarily used by plasma theory students.

*Professor Jack Fix*



# Research

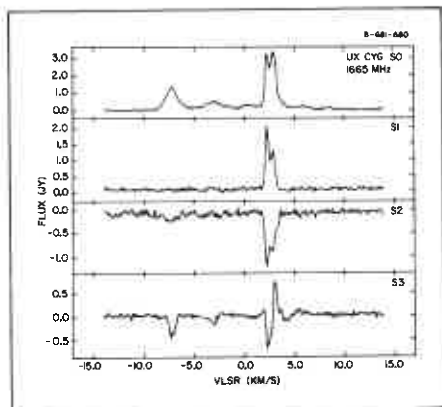

Radio spectra of the star UX Cygni

Professor and Mrs. Thomas Carpenter at the spring picnic



Currently active areas of research include the following:

#### *Experimental:*

- Acoustics of Musical Instruments
- Astronomy (Optical and Radio)
- Atomic and Molecular Physics
- Auroral Physics
- Cosmic Rays
- Elementary Particle Physics
- Laser Physics
- Nuclear Physics
- Low-Temperature Physics
- Magnetospheric Physics
- Planetary Physics
- Plasma Physics
- Solid-State Physics
- Space Plasma Physics

#### *Theoretical:*

- Astrophysics
- Atomic and Molecular Physics
- Elementary Particle Physics
- Nuclear Physics
- Plasma Physics
- Solid-State Physics
- Space Plasma Physics

Research in physics and astronomy is supported by state funds and by the Air Force Office of Scientific Research, the Department of Energy, the National Aeronautics and Space Administration, the National Science Foundation, the Office of Naval Research, and the Petroleum Research Fund. Separately budgeted research expenditures were over \$5 million for the period July 1, 1983-June 30, 1984.

#### **Acoustics**

The acoustics facility includes a reverberant recording room, tape recorders, and a real-time spectrum analyzer for the study of musical sounds. The emphasis is on the physics of plucked string instruments. The equipment has uses in other applications for interdisciplinary studies. The research in musical acoustics is a joint undertaking with the School of Music.

#### **Astronomy and Astrophysics**

Research programs in optical and infrared astronomy are carried out at The University of Iowa observatory near Riverside and at several national observatories. The observatory is equipped for both photometric and spectrophotometric observations. Current research programs include spectrophotometry of comets, novae, binary stars, and stars with unusual energy distributions. Work on surface photometry of comets and emission nebulae is also in progress. Work carried out at national facilities includes photometry, spatial interferometry, and spectroscopy of stellar masers.

Radio astronomy observations are carried out at the North Liberty Radio Observatory (NLRO) near Iowa City as well as at several national observatories. The principal research instrument at the North Liberty Radio Observatory is a 60-foot telescope used for both continuum and spectral-line observations at centimetric wavelengths. Current research programs at the North Liberty Radio Observatory include synoptic studies of 18-cm OH emission from stellar masers, searches for new OH sources, and very long baseline interferometric observations of both OH stellar masers and extragalactic continuum sources. NLRO is one of the observatories in the national Very Long Baseline Interferometry (VLBI) network. Work at national observatories includes spatial mapping of extragalactic, stellar, and solar system objects; observations of molecular clouds; and a variety of VLBI investigations.

Theoretical astrophysics study is concentrated on the gas and dust in the circumstellar envelopes of evolved stars. Topics of current interest include computer simula-

tions of the hydrodynamics and radiative transfer in circumstellar mass flows, the scattering properties of circumstellar dust shells, models of OH masers near the cool stars, and scattering properties of the interstellar medium. Other theoretical work involves study of plasma physics topics of astrophysical importance, particularly the characteristics of nonlinear plasma waves and their interaction with charged particles. The goal of this research is to better understand physical processes in radio sources and the interstellar medium.

#### **Atomic and Molecular Physics**

High vacuum atomic and molecular beam systems are used for the study of collision dynamics in simple molecular systems. Conventional and laser high-resolution spectroscopic studies complementary to these collision dynamics studies are being carried out simultaneously. In several instances, these molecular systems include either actual or potential laser transitions of considerable promise.

Theoretical work in atomic and molecular physics is concerned primarily with determination of atomic and molecular interactions, especially potential energy curves of diatomic molecules. Also of interest are radiative transition probabilities and lifetimes, elastic and inelastic scattering cross sections, corrections to the Born-Oppenheimer separation of electronic and nuclear motion, and the dependence of atomic cluster properties on atomic size.

#### **Elementary Particle Physics**

Experimental research in particle physics is carried out at Fermilab with the charged hyperon facility in collaboration with groups at Iowa State, Yale, and Fermilab.

Theoretical research in elementary particle physics deals with scattering matrix theories of

multipartle reactions, applications of group theory to particle physics, the representation theory of groups (in collaboration with members of the mathematics department), and aspects of completely integrable and nearly completely integrable Hamiltonian systems.

#### **Nuclear Physics**

A versatile 6-MV Van de Graaff accelerator is used to study nuclear reactions induced by all stable isotopes of hydrogen, helium, lithium, and beryllium. A unique design allows energies up to 14 MeV for triply charged ions. Special emphasis is given to the study of lithium-ion reactions where three or more particles are produced. An additional program of the laboratory uses the ion beams for measuring the chemical and physical structure of semiconductor materials. The laboratory also conducts nuclear experiments using higher energy beams at national accelerator facilities.

Theoretical research in nuclear and intermediate energy physics is concerned with the few-body



*Professor Donald Gurnett*

*North Liberty Radio Observatory*







*Professor Wayne Polyzou*

problem. We have an active few-body physics group, and we are engaged in research with scientists at both Argonne National Laboratory and Los Alamos National Laboratory. The group holds weekly discussions and seminars. Current research is involved with the nuclear three-body problem, the few-quark problem, and various topics in relativistic quantum mechanics.

**Plasma Physics**

Research in plasma physics includes the study of basic plasma properties and the applications of basic plasma phenomena to thermonuclear fusion plasmas, space plasmas, and astrophysical plasmas. A particular emphasis is on experiments designed to simulate, in the laboratory, various plasma processes occurring in the ionosphere; this work is being funded by the Office of Naval Research. Some topics under investigation are electrostatic ion cyclotron waves and their relation to ion beam and conic formation in the auroral zone, double layers,



*Professor William Savage*

and ionospheric instabilities. Several plasma devices are available for these studies including a Q-machine, a coaxial double plasma device, and several multidipole plasma devices. In addition, devices are available for studying plasma phenomena associated with the properties of cusp confinement. Some of the work is done in conjunction with the mirror confinement program of the Department of Energy. Experimental study of the properties of solitons is funded through the National Science Foundation. Experimental research on high-power radio waves in ionospheric plasma is performed at the National Astronomy and Ionosphere Center near Arecibo, Puerto Rico.

Theoretical plasma physics uses a combination of analytic and numerical techniques. Two kinds of numerical techniques are used: the nonlinear partial differential fluid equations which describe a plasma are integrated numerically; and Newton's laws of motion together with Maxwell's equations are solved for systems of 1,000 to 1,000,000 particles. The work concentrates on the study of equilibrium, stability, solitons, nonlinear waves, and turbulence in laboratory plasmas, fusion plasmas (especially tandem mirrors), ionospheric plasma, magnetospheric plasmas, space plasmas, and astrophysical plasmas. The numerical work is performed on the campus computers as well as via telephone on the CRAY-1 computers at the National Center for Atmospheric Research in Boulder, Colorado, and the National Magnetic Fusion Energy Computing Center in Livermore, California.

*The Plasma Diagnostics Package during a space shuttle flight*

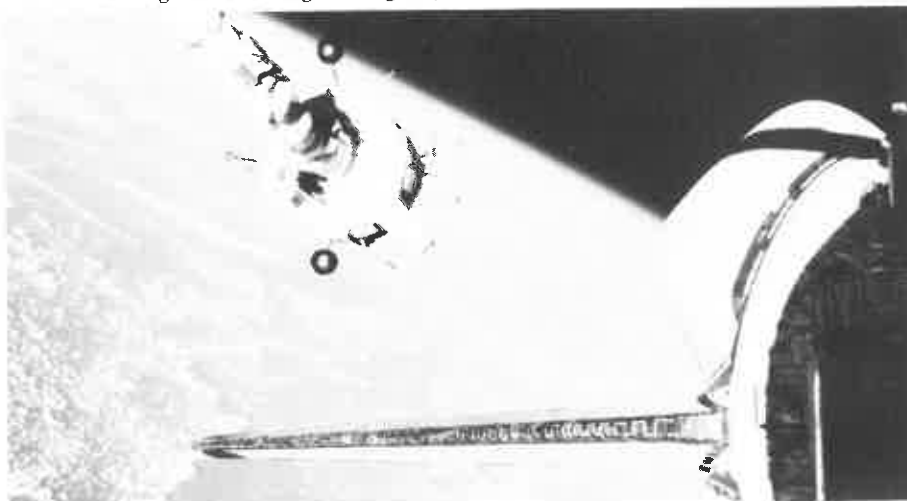

**Solid-State Physics**

Experiments on fundamental thermal, electrical, and magnetic properties of metals, alloys, and compounds are included in the experimental solid-state program.

Currently studies are focused on the samarium monochalcogenide and pnictide compounds and their mutual solid solutions in an investigation of intermediate valence phenomena in rare-earth systems. Experimental work is also concerned with spin-polarized atoms.

Theoretical work in solid-state physics is concerned with the application of various many-body approaches to the theory of the electronic and magnetic properties of condensed matter. Areas of special current interest include valence instabilities in rare-earth compounds and related narrow band phenomena and itinerant magnetism in disordered alloys.

### Space Physics

A major program of experimental and theoretical space physics is conducted as a regular part of the graduate work of the department. Extensive facilities and an engineering and technical staff are available for the design, construction, and testing of equipment for flight in rockets, spacecraft, and the Space Shuttle; the reception of satellite telemetry; and the computerized decoding and analysis of data. Emphasis is on comprehensive observational and theoretical study of (a) the magnetospheres of Earth, Jupiter, and Saturn, (b) the interplanetary medium including the propagation of energetic particles therein, and (c) the galactic cosmic radiation. The space physics group has currently active instruments on IMP-8; Pioneers 10 and 11 now at over 30 AU and 14 AU, respectively, from the sun; International Sun-Earth Explorers 1, 2, and 3; Dynamics Explorer 1; and Voyagers 1 and 2. Several instruments have been flown as parts of Space Shuttle payloads. Two major instruments have been completed for the Galileo (Jupiter Orbiter) mission (1986 launch). Four instruments

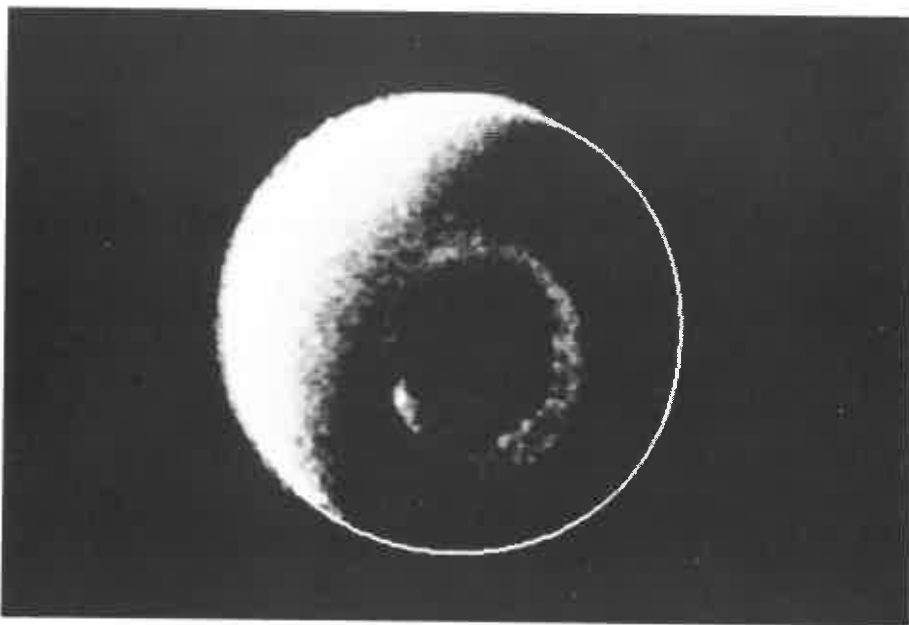

*The Northern lights as seen in ultraviolet light from the Dynamics Explorer spacecraft*

*Professor Nicola D'Angelo uses a computer to analyze experimental plasma physics data*





Professor Steven Spangler



Professor William Klink

are being defined for the International Solar Terrestrial Physics mission. Surveys of the energetic charged particle, plasma, and plasma-wave environment of Saturn were made by Pioneer 11 in September 1979, Voyager 1 in November 1980, and Voyager 2 in August 1981. Voyager 2 will encounter Uranus in 1986 and Neptune in 1989.

Space plasma physics deals mainly with the magnetohydrodynamics, wave-particle interactions, transport, and acceleration of charged particles in planetary magnetospheres. In situ measurements by the various instruments described above enable the research teams to utilize the planetary magnetospheres as natural laboratories for plasma physics. These laboratories provide some unique conditions which are either difficult or impossible to simulate in a man-made laboratory. Due to the complex conditions present in the magnetospheres, this field is still very much in a mode of discovery. As a leading institution in this field, we participate in this sense of discovery in both our observational and theoretical work.

A quantum mechanical wave function from the nuclear three-body problem

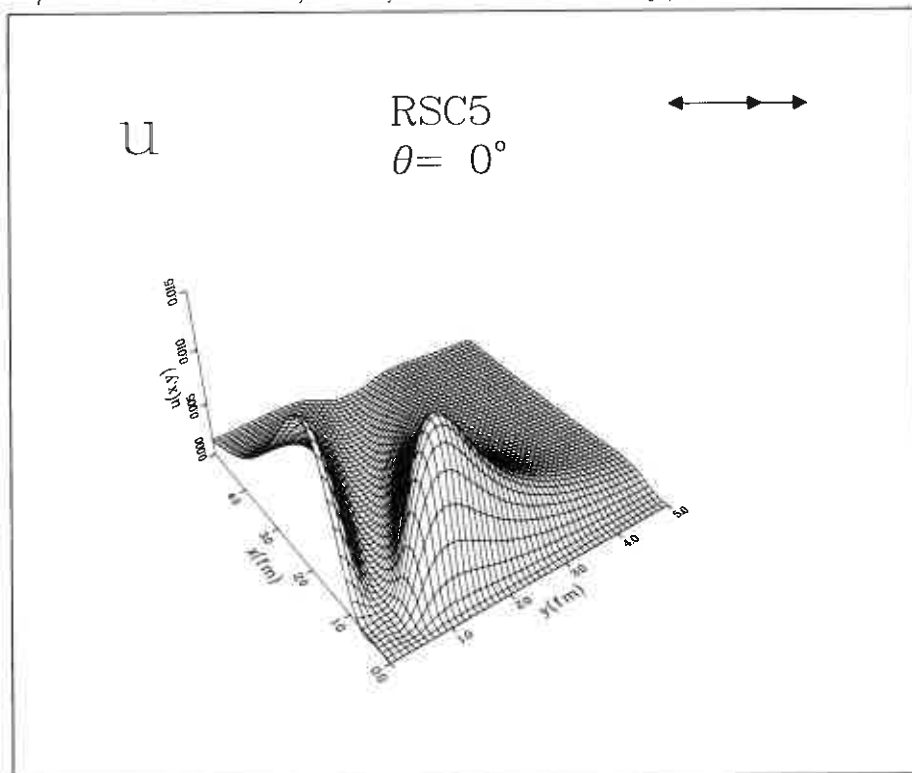

# Recent Recipients of the Ph.D. Degree

(Name, Current Employment,  
Thesis Title)

**1979**

James L. Green, Marshall Space  
Flight Center, Huntsville, Alabama  
"On the Generation of Auroral  
Kilometric Radiation"

William S. Kurth, The University  
of Iowa, Iowa City, Iowa  
"Intense Electrostatic Waves  
near the Upper Hybrid Reso-  
nance Frequency"

Alan J. Marcus, Xonics, Van Nuys,  
California  
"Two-Dimensional Simulation of  
a Plasma in a Periodic Picket  
Fence"

Michael Mond, Ben-Gurion Uni-  
versity of the Negev, Beer-Sheva,  
Israel

"Non-Markovian Theory of  
Strong Turbulence"

Mark E. Pesses, Goddard Space  
Flight Center, Greenbelt, Maryland  
"On the Acceleration of Energetic  
Protons by Interplanetary Shock  
Waves"

Robert B. Phillips, Haystack  
Observatory, Westford, Mas-  
sachusetts

"Milliarcsecond Structure of  
Nine Compact Extragalactic  
Sources at 1671 MHz"

Kevin J. Sisson, Murray State  
University, Murray, Kentucky  
"X-Ray Diffraction Study of the  
Alloy System  $\text{SmP}_x\text{S}_{1-x}$ "

Frederic Ze, Lawrence Livermore  
National Laboratory, Livermore,  
California

"Excitation and Interactions of  
Spherical and Cylindrical Ion-  
Acoustic Solitons"

**1980**

Michael J. Alport, University of  
Natal, Republic of South Africa  
"Bragg Scattering of EM Waves  
from a Laboratory Plasma"

Peter G. Coakley, JAYCOR, San  
Diego, California

"Large Electrostatic Potential  
Variations in Laboratory Plas-  
mas"

Jeffrey L. Parish, Utah State  
University, Logan, Utah  
"The Jovian Magnetosphere"

**1981**

Joseph E. Borovsky, Los Alamos  
National Laboratory, Los Alamos,  
New Mexico (on leave at The  
University of Iowa, Iowa City,  
Iowa)

"The Simulation of Plasma  
Double Layer Structures in Two  
Dimensions"

Mark J. Claussen, California  
Institute of Technology, Pasadena,  
California

"Polarization Properties of Main-  
Line OH Maser Emission from  
Circumstellar Shells of Late-Type  
Variable Stars"



Professor Louis Frank

*Numerical solution for the electric field and the density  
in two plasma solitons which have just collided*

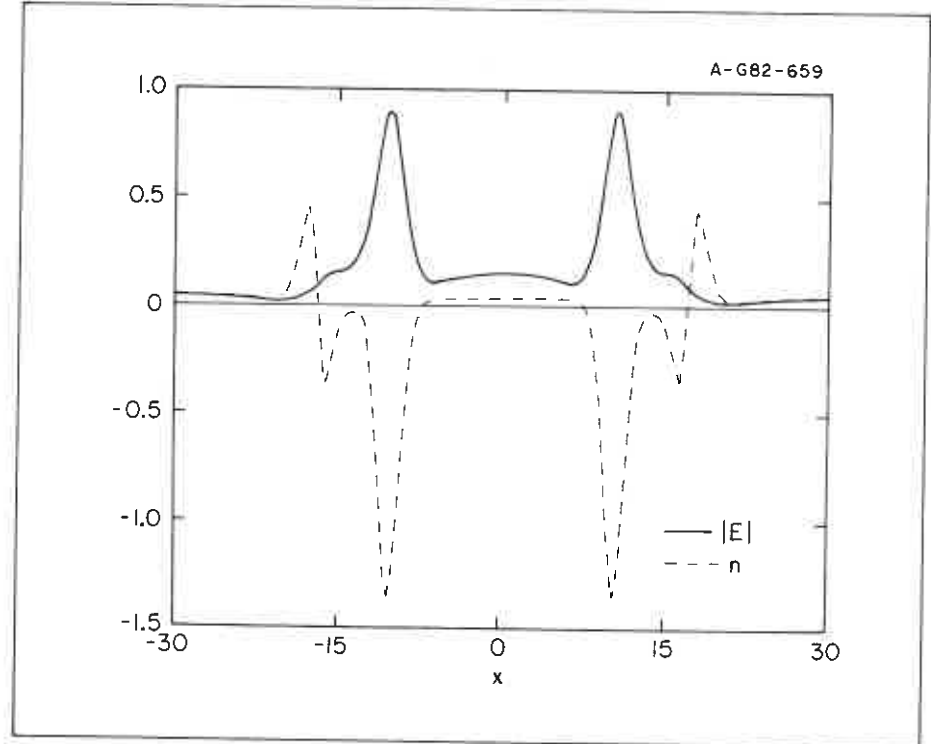



Professor John Schweitzer

Cheryl Yu-Yin Huang, The University of Iowa, Iowa City, Iowa  
 "A Theoretical Study of Plasma-spheric Hiss"

Ping-Tien Wu, Institute of Nuclear Energy Research, Lung-Tan, Taiwan, R.O.C.  
 "A Theoretical Study of Plasma-spheric Hiss"

**1982**  
 Dennis L. Gallagher, University of Alabama, Huntsville, Alabama  
 "Short Wavelength Electrostatic Waves in the Earth's Magneto-sheath"

Lee A. Reinleitner, Marshall Space Flight Center, Huntsville, Alabama  
 "Whistler Mode Chorus Generation of Beam Driven Electrostatic Bursts"

**1983**  
 Paul J. Hansen, Clarkson College of Technology, Potsdam, New York  
 "Studies in Weak Turbulence"

Robert L. Tokar, Los Alamos National Laboratory, Los Alamos, New Mexico  
 "Whistler Mode Turbulence at Earth's Bow Shock: Generation via Electron Beams and Ray Path Integrated Amplification"

**1984 (Partial)**  
 David J. Doiron, The University of Iowa, Iowa City, Iowa  
 "Radio Emission in RS CVn Binary Stars"

Stephen A. Fuselier, Los Alamos National Laboratory, Los Alamos, New Mexico  
 "The Downshift of Electron Plasma Oscillations in the Electron Foreshock Region"

Mark W. Hodges, Owens Valley Radio Observatory, Big Pine, California  
 "VLBI Observations of Compact Double Radio Sources"

Nojan Omidi, University of Maryland, College Park, Maryland  
 "Generation of Auroral Kilometric and Z-Mode Radiation by the Cyclotron Maser Instability"

Professor William Stwalley studies laser-induced plasmas and metal vapors with a microprocessor-controlled Nd:YAG/Dye laser



# Recent Publications

1. D. A. GURNETT, S. D. SHAWHAN, and R. R. SHAW. "Auroral Hiss, Z Mode Radiation, and Auroral Kilometric Radiation in the Polar Magnetosphere: DE 1 Observations." *J. Geophys. Res.* 88 (1983):329-40.

2. K. B. DYSTHE, H. L. PÉCSELI, and J. TRULSEN. "Stochastic Generation of Continuous Wave Spectra." *Phys. Rev. Lett.* 50 (1983):353-56.

3. K. B. DYSTHE, E. MJOLHUS, H. L. PÉCSELI, and K. RYPDAL. "A Thermal Oscillating Two-Stream Instability." *Phys. Fluids* 26 (1983):146-57.

4. STANLEY D. SHAWHAN and GERALD B. MURPHY. "Plasma Diagnostics Package Assessment of the STS-3 Orbiter Environment and Systems for Science." *American Institute of Aeronautics and Astronautics*, Paper No. AIAA-83-0253.

5. JOSEPH E. BOROVSKY and GLENN JOYCE. "The Simulation of Plasma Double-Layer Structures in Two Dimensions." *J. Plasma Phys.* 29 (1983):45-84.

6. J. L. FRIAR, B. F. GIBSON, and G. L. PAYNE. "Three-Nucleon Forces and Meson-Exchange Currents in the Trinucleon." *Comments Nucl. Part. Phys.* 11 (1983):51-61.

7. JAMES A. VAN ALLEN. "Foreword." *Physics of the Jovian Magnetosphere*, edited by A. J. Dessler, xi-xii. New York: Cambridge University Press, 1983.

8. A. W. SCHARDT and C. K. GOERTZ. "High-Energy Particles." In *Physics of the Jovian Magnetosphere*, edited by A. J. Dessler, 157-96. New York: Cambridge University Press, 1983.

9. D. A. GURNETT and F. L. SCARF. "Plasma Waves in the Jovian Magnetosphere." In *Physics of the Jovian Magnetosphere*, edited by A. J. Dessler, 285-316. New York: Cambridge University Press, 1983.

10. MELVYN L. GOLDSTEIN and C. K. GOERTZ. "Theories of Radio Emissions and Plasma Waves." In *Physics of the Jovian Magnetosphere*, edited by A. J. Dessler, 317-52. New York: Cambridge University Press, 1983.

11. T. W. HILL, A. J. DESSLER, and C. K. GOERTZ. "Magnetospheric Models." In *Physics of the Jovian Magnetosphere*, edited by A. J. Dessler, 353-94. New York: Cambridge University Press, 1983.

12. D. R. NICHOLSON. "Topics in Strong Langmuir Turbulence." *Physica Scripta* 27 (1983):77-82.

13. DWIGHT R. NICHOLSON. *Introduction to Plasma Theory*. New York: John Wiley & Sons, 1983.

14. M. M. SHAPIRO and R. SILBERBERG. "Cosmic Rays from Active Galactic Nuclei and in Metagalactic Space." *Astrophys. J.* 265 (1983):570-72.

15. S. D. SHAWHAN. "Estimation of Wave Vector Characteristics." *Adv. Space Res.* 2 (1983):31-41.

16. JOHN T. BAHNS, K. K. VERMA, A. R. RAJAEI-RIZI, and W. C. STWALLEY. "Optically Pumped Ring Laser Oscillation to Vibrational Levels near Dissociation and to the Continuum in Na<sub>2</sub>." *Appl. Phys. Lett.* 42 (1983):336-38.

17. ROGER R. ANDERSON. "Plasma Waves in Planetary Magnetospheres." *Rev. Geophys. Space Phys.* 21 (1983):474-94.

18. MEHYAR KHAZEI, EDWARD F. GABL, JEFFREY M. BULSON, JAMES P. SHEERIN, YOSHIHARU NAKAMURA, and KARL E. LONNGREN. "Ion-Acoustic Soliton Propagation in a Density Well." *IEEE PS-11* (1983):46-47.

19. ROBERT F. FERRANTE and WILLIAM C. STWALLEY. "Spin-Polarized Atomic Nitrogen and the  ${}^7\Sigma_u^+$  State of N<sub>2</sub>." *J. Chem. Phys.* 78 (1983):3107-11.

20. K. K. VERMA, J. T. BAHNS, A. R. RAJAEI-RIZI, W. C. STWALLEY, and W. T. ZEMKE. "First Observation of Bound-Continuum Transitions in the Laser-Induced A  ${}^1\Sigma_u^+$  - X  ${}^1\Sigma_g$  Fluorescence of Na<sub>2</sub>." *J. Chem. Phys.* 78(1983):3599-3613.

21. K. K. VERMA, M. E. KOCH, and W. C. STWALLEY. "Observation of Levels near Dissociation in the X  ${}^1\Sigma_g^+$  State of  ${}^7\text{Li}_2$ ." *J. Chem. Phys.* 78 (1983):3614-22.

22. C. K. GOERTZ and G. MORFILL. "A Model for the Formation of Spokes in Saturn's Ring." *Icarus* 53 (1983):219-29.



Professor Howard Laster

Riverside Astronomical Observatory





Professor Georg Knorr

23. D. A. GURNETT, E. GRÜN, D. GALLAGHER, W. S. KURTH, and F. L. SCARF. "Micron-Sized Particles Detected near Saturn by the Voyager Plasma Wave Instrument." *Icarus* 53 (1983):236-54.

24. W. S. KURTH, D. A. GURNETT, and F. L. SCARF. "A Search for Saturn Electrostatic Discharges in the Voyager Plasma Wave Data." *Icarus* 53 (1983):255-61.

25. D. A. GURNETT, W. S. KURTH, and F. L. SCARF. "Narrow-band Electromagnetic Emissions from Jupiter's Magnetosphere." *Nature* 302 (1983):385-88.

26. S. C. YANG, D. D. NELSON, JR., and W. C. STWALLEY. "The Dissociation Energies of the Diatomic Alkali Hydrides." *J. Chem. Phys.* 78 (1983):4541-43.

27. LEE A. REINLEITNER, DONALD A. GURNETT, and TIMOTHY E. EASTMAN. "Electrostatic Bursts Generated by Electrons in Landau Resonance with Whistler Mode Chorus." *J. Geophys. Res.* 88 (1983):3079-93.

28. JOSEPH E. BOROVSKY and GLENN JOYCE. "Numerically Simulated Two-Dimensional Auroral Double Layers." *J. Geophys. Res.* 88 (1983):3116-26.

29. M. M. MADSEN, N. D'ANGELO, and I. B. IVERSEN. "Observations of Unusual Structures of High-Latitude Stratospheric Electric Fields." *J. Geophys. Res.* 88 (1983):3894-96.

30. D. P. MURPHY, G. C. GOLDENBAUM, C. CHIN-FATT, Y. P. CHONG, A. W. DeSILVA, H. R. GRIEM, R. A. HESS, and R. L. MERLINO. "Macroscopic Plasma Behavior in a High-Voltage Toroidal Theta Pinch." *Phys. Fluids* 26 (1983):1061-70.

31. J. C. WEATHERALL, D. R. NICHOLSON, and M. V. GOLDMAN. "Steady-State Turbulence with a Narrow Inertial Range." *Phys. Fluids* 26 (1983):1103-13.

32. E. NORBECK and T. Z. MA. "Measurement of Depth Distribution of Phosphorus in Films of Phosphosilicate Glass by Means of  $^{31}\text{P}(p,\alpha)^{28}\text{Si}$ ." *IEEE Trans. on Nuclear Science* NS-30 (1983):1347-48.

33. MICHAEL D. STRATHAM and E. NORBECK. "A New Type of Charging Belt for Van de Graaff Accelerators." *IEEE Trans. on Nuclear Science* NS-30 (1983):1502-3.

34. W.-H. IP and C. K. GOERTZ. "An Interpretation of the Dawn-Dusk Asymmetry of the EUV Emission from the Io Plasma Torus." *Nature* 302 (1983):232-33.

35. J. L. FRIAR, B. F. GIBSON, and G. L. PAYNE. "The Proton-Deuteron Scattering Lengths." *Phys. Lett.* 124B (1983):287-92.

36. N. D'ANGELO, T. NEUBERT, I. B. IVERSEN, and M. M. MADSEN. "High-Latitude Stratospheric Winds near Summer Solstice: The Diurnal and Semidiurnal Solar Tides." *J. Geophys. Res.* 88 (1983):5260-64.

37. N. D'ANGELO, I. B. IVERSEN, and M. MØHL MADSEN. "Low-Frequency ( $f \leq 1$  Hz) Stratospheric Electrical Noise Measured by Balloon-Borne Sensors." *J. Geophys. Res.* 88 (1983):5441-50.

38. G. L. PAYNE, D. R. NICHOLSON, and R. M. DOWNIE. "Numerical Solution of the Zakharov Equations." *J. Comp. Phys.* 50 (1983):482-98.

39. C. K. GOERTZ. "Detached Plasma in Saturn's Front Side Magnetosphere." *Geophys. Res. Lett.* 10 (1983):455-58.

40. S. D. SHAWHAN, J. L. BURCH, and R. W. FREDRICKS. "Subsatellite Studies of Wave, Plasma, and Chemical Injections from Spacelab." *J. Spacecraft and Rockets* 20 (1983):238-44.

Van Allen Hall from the southeast



41. W. H. KLINK. "On the Reduction of  $n$ -Fold Tensor Products in  $SU(2)$ ." *J. Phys. A: Math. Gen.* 16 (1983):1845-54.

42. W. H. KLINK. "The  $SO(3) \subset SU(3)$  Problem from a Holomorphic Induction Point of View." *J. Phys. A: Math. Gen.* 16 (1983):1855-67.

43. M. A. F. GOMES, WM. R. SAVAGE, and ANDERSON S. L. GOMES. "Local Stability: An Elementary Demonstration and Discussion." *Am. J. Phys.* 51 (1983):636-40.

44. R. L. RAIRDEN, L. A. FRANK, and J. D. CRAVEN. "Geocoronal Imaging with Dynamics Explorer: A First Look." *Geophys. Res. Lett.* 10 (1983):533-36.

45. D. A. GURNETT and C. K. GOERTZ. "Ion Cyclotron Waves in the Io Plasma Torus: Polarization Reversal of Whistler Mode Noise." *Geophys. Res. Lett.* 10 (1983):587-90.

46. J. T. BERGSTRALH and J. S. NEFF. "Absolute Spectrophotometry of Neptune: 3390 to 7800 Å." *Icarus* 55 (1983):40-49.

47. W. C. STWALLEY. "A Hybrid Laser-Magnet Trap for Spin-Polarized Atoms." In *Laser-Cooled and Trapped Atoms* (Proceedings, Workshop on Spectroscopic Applications of Slow Atomic Beams, Gaithersburg, Maryland, April 14-15, 1983), edited by W. D. Phillips, 95-102. National Bureau of Standards (U.S.) Special Publication 653, 1983.

48. M. E. KOCH, K. K. VERMA, J. T. BAHNS, and W. C. STWALLEY. "Laser-Induced Plasmas in Alkali Metal Vapors." In *Proceedings, International Conference on Lasers '82*, 1983.

49. J. T. BAHNS, A. R. RAJAEIRIZI, K. K. VERMA, F. B. ORTH, and W. C. STWALLEY. "New Alkali Metal Dimer Optically Pumped Lasers." In *Proceedings, International Conference on Lasers '82*, 1983.

50. W. CALVERT. "The Source Location of Certain Jovian Decametric Radio Emissions." *J. Geophys. Res.* 88 (1983):6165-70.

51. U. S. INAN, R. A. HELLIWELL, and W. S. KURTH. "Terrestrial Versus Jovian VLF Chorus: A Comparative Study." *J. Geophys. Res.* 88 (1983):6171-80.

52. C. Y. HUANG and C. K. GOERTZ. "Ray-Tracing Studies and Path-Integrated Gains of ELF Unducted Whistler Mode Waves in the Earth's Magnetosphere." *J. Geophys. Res.* 88 (1983):6181-87.

53. STEVEN R. SPANGLER, ROBERT L. MUTEL, and JOHN M. BENSON. "VLBI Observations of the Radio Sources 0552 + 398 and 1848 + 283: Measurements of the Departure from Equipartition." *Astrophys. J.* 271 (1983):44-50.

54. STEVEN R. SPANGLER. "Determination of the Properties of Magnetic Turbulence in Radio Sources." *Astrophys. J.* 271 (1983):L49-L53.

55. D. A. GURNETT and L. A. REINLEITNER. "Electron Acceleration by Landau Resonance with Whistler Mode Wave Packets." *Geophys. Res. Lett.* 10 (1983):603-6.

56. DONALD A. GURNETT. "High Latitude Electromagnetic Plasma Wave Emissions." In *High-Latitude Space Plasma Physics*, edited by Bengt Hultqvist and Tor Hagfors, 355-75. Plenum Publishing Corporation, 1983.

57. C. K. GOERTZ and J. E. BOROVSKY. "Numerical Simulations of Plasma Double Layers." In *High-Latitude Space Plasma Physics*, edited by Bengt Hultqvist and Tor Hagfors, 469-92. Plenum Publishing Corporation, 1983.

58. JAMES A. VAN ALLEN. "Absorption of Energetic Protons by Saturn's Ring G." *J. Geophys. Res.* 88 (1983):6911-18.

59. CROCKETT L. GRABBE. "Reply." *J. Geophys. Res.* 88 (1983):7259-60.

60. STEVEN R. SPANGLER and JAMES P. SHEERIN. "Alfvén Wave Collapse and the Stability of a Relativistic Electron Beam in a Magnetized Astrophysical Plasma." *Astrophys. J.* 272 (1983):273-78.

61. C. ANKENBRANDT, E. MCCLIMENT et al. "Precise Measurement of the  $\Sigma^+$  Magnetic Moment." *Phys. Rev. Lett.* 51 (1983):863-66.

62. EDWIN NORBECK and MICHAEL D. STRATHMAN. "Poly-C Van de Graaff Belts." *Nucl. Instrum. Methods* 215 (1983):7-8.



Professor Stanley Shawhan

Simplified drawing of the Pioneer 10/Pioneer 11 spacecraft

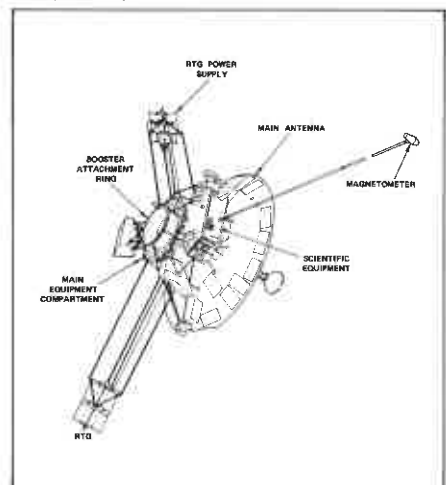





Professor Richard Carlson

63. J. L. FRIAR, B. F. GIBSON, and G. L. PAYNE. "Configuration Space Faddeev Continuum Calculations: p-d s-Wave Scattering Length." *Phys. Rev. C* 28 (1983):983-94.

64. E. NORBECK, P. T. WU, C. R. CHEN, and R. R. CARLSON. " ${}^6\text{Li}$ - ${}^6\text{Li}$  and  ${}^7\text{Li}$ - ${}^7\text{Li}$  Elastic Scattering from 2.0 to 5.5 MeV." *Phys. Rev. C* 28 (1983):1140-47.

65. M. M. SHAPIRO and R. SILBERBERG. "Gamma Rays and Neutrinos as Complementary Probes in Astrophysics." *Space Science Reviews* 36 (1983):51-56.

66. REIN SILBERBERG, C. H. TSAO, JOHN R. LETAW, and M. M. SHAPIRO. "Distributed Acceleration of Cosmic Rays." *Phys. Rev. Lett.* 51 (1983):1217-20.

67. J. P. SHEERIN and D. R. NICHOLSON. "Theory of Radar Detection of Solitons during Ionospheric Heating." *Phys. Lett.* 97A (1983):395-98.

68. G. E. MORFILL and C. K. GOERTZ. "Plasma Clouds in Saturn's Rings." *Icarus* 55 (1983):111-23.

69. MAURICE M. SHAPIRO. "Preface." In *Composition and Origin of Cosmic Rays*, edited by M. M. Shapiro, ix-x. D. Reidel Publishing Company, 1983.

70. R. SILBERBERG and M. M. SHAPIRO. "Sources of Extragalactic Cosmic Rays: Photons and Neutrinos as Probes." In *Composition and Origin of Cosmic Rays*, edited by M. M. Shapiro, 231-44. D. Reidel Publishing Company, 1983.

71. C. K. GOERTZ. "Nonstationary Coupling between the Magnetosphere and Ionosphere." In *Proceedings, Sixth ESA Symposium on European Rocket and Balloon Programmes (ESA SP-183)*, April 11-15, 1983. Interlaken, Switzerland, 221-28.

72. C. K. GOERTZ. "The Io-Control of Jupiter's Decametric Radiation: The Alfvén Wave Model." *Adv. Space Res.* 3 (1983):59-70.

73. G. E. MORFILL, H. FECHTIG, E. GRÜN, and C. K. GOERTZ. "Some Consequences of Meteoroid Impacts on Saturn's Rings." *Icarus* 55 (1983):439-47.

74. A. T. Y. LUI, T. E. EASTMAN, D. J. WILLIAMS, and L. A. FRANK. "Observations of Ion Streaming during Substorms." *J. Geophys. Res.* 88 (1983):7753-64.

75. C. Y. HUANG, C. K. GOERTZ, and R. R. ANDERSON. "A Theoretical Study of Plasmaspheric Hiss Generation." *J. Geophys. Res.* 88 (1983):7927-40.

76. M. W. J. SCOURFIELD, J. G. KEYS, E. NIELSEN, AND C. K. GOERTZ. "Evidence for the  $E \times B$  Drift of Pulsating Auroras." *J. Geophys. Res.* 88 (1983):7983-88.

77. W. L. IMHOF, J. B. REAGAN, E. E. GAINES, and R. R. ANDERSON. "Narrow Spectral Peaks in Electrons Precipitating from the Slot Region." *J. Geophys. Res.* 88 (1983):8103-10.

78. P. J. HANSEN and D. R. NICHOLSON. "Weak Cubic Langmuir Turbulence." *Phys. Fluids* 26 (1983):3008-17.

79. S. D. SHAWHAN. "A Spacelab Principal Investigator's Guidance for Planning Scientific Experiments Using the Shuttle." *J. Spacecraft and Rockets* 20 (September-October 1983):477-83.

Radio image of the radio galaxy 3 C 430, made with the Very Large Array at a frequency of 1446 MHz

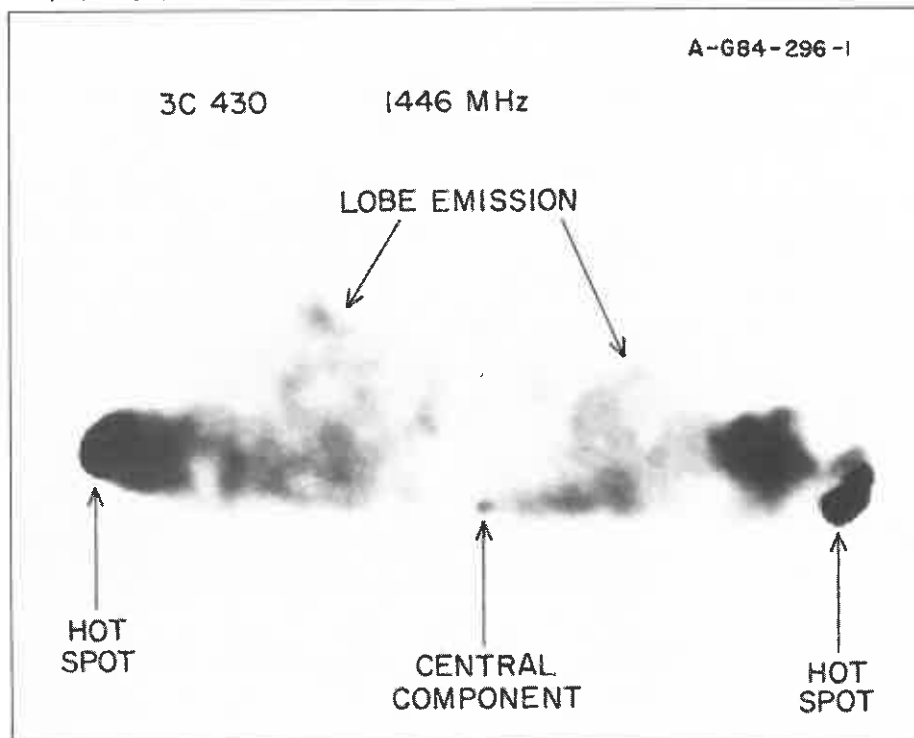

80. R. P. LEPPING, M. D. DESCH, L. W. KLEIN, E. C. SITTLER, JR., J. D. SULLIVAN, W. S. KURTH, and K. W. BEHANNON. "Structure and Other Properties of Jupiter's Distant Magnetotail." *J. Geophys. Res.* 88 (1983):8801-15.

81. W. S. KURTH, F. L. SCARF, D. A. GURNETT, and D. D. BARBOSA. "A Survey of Electrostatic Waves in Saturn's Magnetosphere." *J. Geophys. Res.* 88 (1983):8959-70.

82. F. L. SCARF, D. A. GURNETT, W. S. KURTH, and R. L. POYNTER. "Voyager Plasma Wave Measurements at Saturn." *J. Geophys. Res.* 88 (1983):8971-84.

83. JAMES A. VAN ALLEN. "On Being President of AGU" (Editorial). *EOS, Trans. Am. Geophys. Union* 64 (1983):945.

84. J. A. VAN ALLEN. "Genesis of the International Geophysical Year." *EOS, Trans. Am. Geophys. Union* 64 (1983):977.

85. A. M. PERSOON, D. A. GURNETT, and S. D. SHAWHAN. "Polar Cap Electron Densities from DE 1 Plasma Wave Observations." *J. Geophys. Res.* 88 (1983):10,123-10,136.

86. JAMES A. VAN ALLEN. *Origins of Magnetospheric Physics*. Washington, D.C.: Smithsonian Institution Press, 1983.

87. N. H. STONE, U. SAMIR, K. H. WRIGHT, JR., D. L. REASONER, and S. D. SHAWHAN. "Multiple Ion Streams in the Near Vicinity of the Space Shuttle." *Geophys. Res. Lett.* 10 (1983):1215-18.

88. STEVEN CARTIER and ROBERT BOSCH. "Wide-Range Langmuir Probe Sweep Circuit." *Rev. Sci. Instrum.* 54 (1983):1789-90.

89. R. L. MUTEL and R. A. GAUME. "A Design Study for a Dedicated VLBI Array." NRAO VLBA Memo Series No. 127.

90. R. A. PRESTON, J. F. LES-TRADE, and R. L. MUTEL. "Linking Hipparcos Observations to an Extragalactic VLBI Frame by Use of Optically Bright Radio Stars." In *Proceedings, F.A.S.T. Thinkshop*, edited by P. L. Bernacca, 395-402.

91. C. K. CHU, A. V. DENIZ, D. J. ELKIN, G. ERLEBACHER, R. A. GROSS, R. IZZO, S. JOHNSTON, C.

KOSTEK, F. LEVINTON, M. MACHIDA, T. C. MARSHALL, R. L. MERLINO, G. A. NAVRATIL, and D. OEPTS. "High-Beta Tokamak Plasma Physics Studies." In *Proceedings, Ninth International Conference on Plasma Physics and Controlled Nuclear Fusion Research 1982*, September 1-8, 1982, Baltimore, Maryland, Vol. II 321-29. Vienna: International Atomic Energy Agency, 1983.

92. L. A. FRANK, C. Y. HUANG, and T. E. EASTMAN. "Currents in the Earth's Magnetosphere." In *Magnetospheric Currents*, edited by T. A. Potemra, 147-57. AGU Geophysical Monograph 28, 1983.

93. J. D. CRAVEN, Y. KAMIDE, L. A. FRANK, S.-I. AKASOFU, and M. SUGIURA. "Distribution of Aurora and Ionospheric Currents Observed Simultaneously on a Global Scale." In *Magnetospheric Currents*, edited by T. A. Potemra, 137-46. AGU Geophysical Monograph 28, 1983.

94. S. D. SHAWHAN and G. B. MURPHY. "STS-3/OSS-1 Plasma Diagnostics Package (PDP) Measurements of the Temperature, Pressure, and Plasma Environment." In *Proceed-*

*ings, NASA Workshop on the Shuttle/Spacelab Environment*, February 1983, A-207—A-231.

95. G. B. MURPHY and S. D. SHAWHAN. "STS-3/OSS-1, Plasma Diagnostics Package (PDP) Measurements of Orbiter Transmitter and Subsystem Electromagnetic Interference." In *Proceedings, NASA Workshop on the Shuttle/Spacelab Environment*, February 1983, A-233—A-250.

96. P. M. BANKS, P. R. WILLIAMSON, J. H. RAITT, and S. D. SHAWHAN. "Electron Beam Experiments aboard the Space Shuttle." *Proceedings, International Symposium for Active Experiments in Space*, 1983.

97. G. B. MURPHY, S. D. SHAWHAN, L. A. FRANK, N. D'ANGELO, D. A. GURNETT, J. M. GREBOWSKY, D. L. REASONER, and N. STONE. "Interaction of the Space Shuttle Orbiter with the Ionospheric Plasma." In *Proceedings, 17th ESLAB Symposium on Spacecraft/Plasma Interactions and Their Influence on Field and Particle Measurements*, Noordwijk, The Netherlands, September 13-16, 1983 (ESA SP-198, publ. December 1983), 73-78.

*Professor Karl Lonngren and a graduate student analyze nonlinear waves in a plasma experiment*

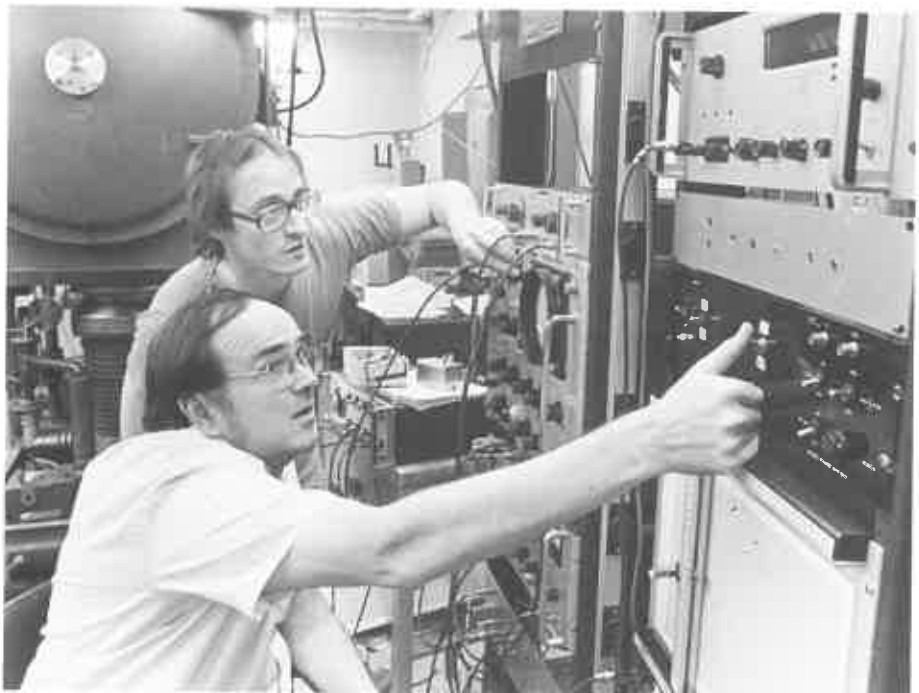

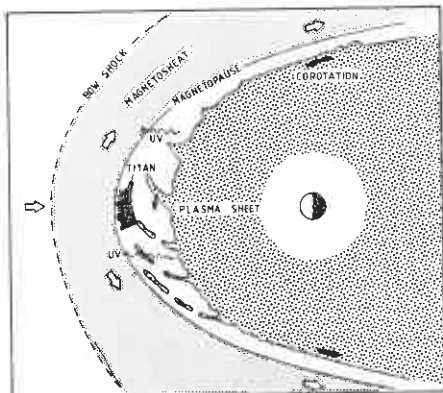

A schematic view of the Saturnian magnetosphere including the plasma sheet whose outer boundary is unstable

98. W. PATERSON, L. A. FRANK, H. OWENS, J. S. PICKETT, G. B. MURPHY, and S. D. SHAWHAN. "Suprathermal Plasma Observed on the STS-3 Mission by the Plasma Diagnostics Package." *Proceedings, USAF/NASA Spacecraft Environmental Interactions Technology Conference, U. S. Air Force Academy, Colorado Springs, Colorado, October 4-6, 1983.*

99. G. B. MURPHY, J. S. PICKETT, W. S. RAITT, and S. D. SHAWHAN. "Electron and Ion Density Depletions Measured in the STS-3 Orbiter Wake." In *Proceedings, USAF/NASA Spacecraft Environmental Interactions Technology Conference, U.S. Air Force Academy, Colorado Springs, Colorado, October 4-6, 1983.*

100. GERALD B. MURPHY, STANLEY D. SHAWHAN, and JOLENE S. PICKETT. "Perturbations to the Plasma Environment Induced by the Orbiter's Maneuvering Thrusters." In *Proceedings, AIAA Shuttle Environment and Operations Meeting, Paper No. 83-2599, Washington, D.C., October 31-November 2, 1983, 59-65.*

101. J. A. FEJER, C. A. GONZALES, H. M. IERKIC, M. SULZER, F. T. DJUTH, L. M. DUNCAN, and J. P. SHEERIN. "The HF-Enhanced Plasma Line." In *Active Experiments in Space.* New York: Plenum Press, 1983.

102. S. R. SPANGLER and J. P. SHEERIN. "Nonlinear Effects and the Limitation of Electron Streaming Instabilities in Astrophysics." In *Unstable Current Systems and Plasma Instabilities in Astrophysics, IAU Symposium 107, edited by M. R. Kundu and G. D. Holman. Dordrecht, Holland: D. Riedel Publ. Co., 1983.*

103. J. L. FRIAR, B. F. GIBSON, and G. L. PAYNE. "Configuration Space Faddeev Calculations." *Z. Phys. A-Atoms and Nuclei*, 312 (1983):169-75.

104. T. H. VU, K. K. VERMA, and W. C. STWALLEY. "Laser-Induced Fluorescence of Na<sub>2</sub> at the Na (3s → 5s) Two Photon Transition." *J. Mol. Spectrosc.* 100 (1983):429-36.

105. Y. C. CHAN and W. C. STWALLEY. "Gas Phase Equilibria of Isotopic Lithium Systems I. Pure Lithium." *J. Chem. Thermodynamics* 15 (1983):989-93.

106. Y. C. CHAN and W. C. STWALLEY. "Gas Phase Equilibria of Isotopic Lithium Systems II. Lithium and Hydrogen." *J. Chem. Thermodynamics* 15 (1983):995-1000.

107. D. R. HARDING and W. C. STWALLEY. "Analysis of the B<sup>1</sup> Π<sub>μ</sub> → X<sup>1</sup> Σ<sub>q</sub><sup>+</sup> Band System of <sup>7</sup>Li<sub>2</sub> Molecule Excited by the 4545- and 5287 Å Visible Lines of the Argon Ion Laser." *J. Mol. Spectrosc.* 102 (1983):67-78.

108. W. T. LUH and W. C. STWALLEY. "The X<sup>1</sup> Σ<sup>+</sup>, A<sup>1</sup> Π and B<sup>1</sup> Σ<sup>+</sup> Potential Energy Curves and Spectroscopy of BH." *J. Mol. Spectrosc.* 102 (1983):212-23.

109. F. R. ORNELLAS, W. C. STWALLEY, and W. T. ZEMKE. "Radiative Transition Probabilities, Lifetimes and Dipole Moments for all Vibrational Levels in the X<sup>1</sup> Σ<sup>+</sup> State of the Beryllium Hydride Ion." *J. Chem. Phys.* 79 (1983):5311-15.

110. M. M. SHAPIRO, R. SILBERBERG, C. H. TSAO, and J. R. LETAW. "Models for Cosmic Ray Propagation at Energies 10<sup>8</sup>-10<sup>14</sup>eV." In *Proceedings, Nineteenth International Cosmic Ray Conference, Bangalore, India, 2* (1983):179.

111. M. M. SHAPIRO, R. SILBERBERG, C. H. TSAO, and J. R. LETAW. "Propagation and Origin of Energetic Cosmic Rays, 10<sup>14</sup>-10<sup>19</sup> eV." In *Proceedings, Nineteenth International Cosmic Ray Conference, Bangalore, India, 2* (1983):283.

Professor Robert Merlino

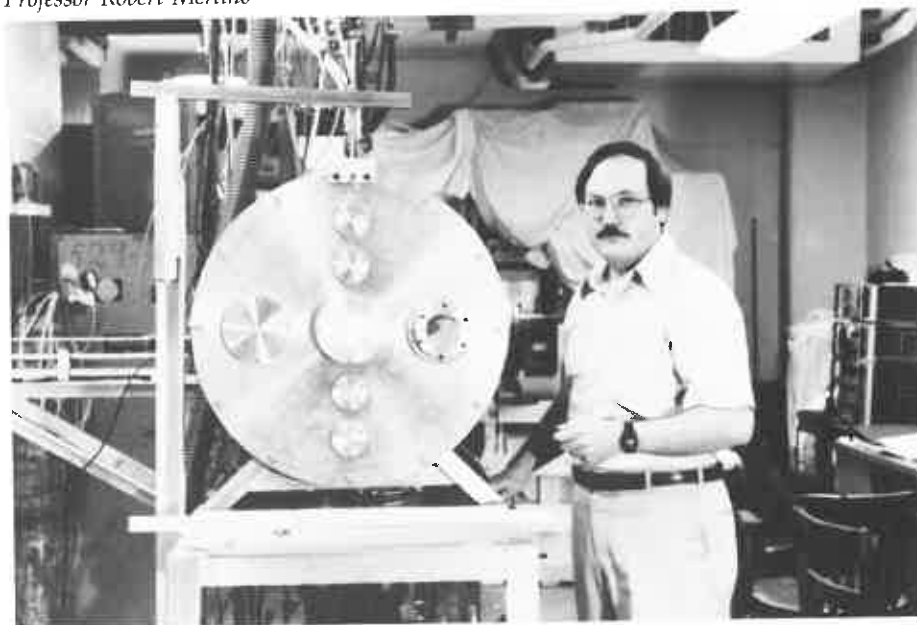

112. J. E. BOROVSKY, M. B. PONGRATZ, R. A. ROUSSEL-DUPRÉ, and T. H. TAN. "The Laboratory Simulation of Unmagnetized Supernova Remnants: Absence of a Blast Wave." *Astrophys. J.* 280 (1984):802-8.

113. M. E. PESSES, J. A. VAN ALLEN, B. T. TSURUTANI, and E. J. SMITH. "High Time Resolution Observations of Corotating Interaction Region Proton Events by Pioneer 11." *J. Geophys. Res.* 89 (1984):37-46.

114. L. A. REINLEITNER, W. S. KURTH, and D. A. GURNETT. "Chorus-Related Electrostatic Bursts at Jupiter and Saturn." *J. Geophys. Res.* 89 (1984):75-83.

115. S. A. FUSELIER and D. A. GURNETT. "Short Wavelength Ion Waves Upstream of the Earth's Bow Shock." *J. Geophys. Res.* 89 (1984):91-103.

116. CROCKETT L. GRABBE. "A Model for Chorus Associated Electrostatic Bursts." *J. Geophys. Res.* 89 (1984):919-23.

117. C. S. LIN, J. L. BURCH, S. D. SHAWHAN, and D. A. GURNETT. "Correlation of Auroral Hiss and Upward Electron Beams near the Polar Cusp." *J. Geophys. Res.* 89 (1984):925-35.

118. J. D. PEREZ and G. L. PAYNE. "Stopping Power of Weakly Unstable Plasmas." *Phys. Fluids* 27 (1984):427-31.

119. JEFFRY M. BULSON, KHOA HUYNH, EDWARD F. GABL, and KARL E. LONNGREN. "Perturbing Conductor Effects on Wave Studies in a Double Plasma Device." *J. Appl. Phys.* 55 (1984):693-96.

120. TIMOTHY E. EASTMAN and EVAN FALES. Review of *Other Worlds: Space, Superspace, and the Quantum Universe* by Paul Davies. *Foundations of Physics* 14 (1984):89-99.

121. A. T. Y. LUI, D. J. WILLIAMS, T. E. EASTMAN, L. A. FRANK, and S.-I. AKASOFU. "Streaming Reversal of Energetic Particles in the Magnetotail during a Substorm." *J. Geophys. Res.* 89 (1984):1540-52.

122. T. E. EASTMAN, L. A. FRANK, W. K. PETERSON, and W. LENNARTSSON. "The Plasma Sheet Boundary Layer." *J. Geophys. Res.* 89 (1984):1553-72.

123. C. K. GOERTZ and W.-H. IP. "A Dawn-to-Dusk Electric Field in the Jovian Magnetosphere." *Planet. Space Sci.* 32 (1984):179-85.

124. EDWARD R. McCLIMENT. *Physics*. San Diego: Harcourt Brace Jovanovich, 1984.

125. R. L. MUTEL, D. J. DOIRON, J. F. LESTRADE, and R. B. PHILLIPS. "VLBI Observations of the RS Canum

Venaticorum Binary Systems UX Arietis and HR 1099 at 1.65 GHz." *Astrophys. J.* 278 (1984):220-23.

126. JOSEPH E. BOROVSKY. "The Production of Ion Conics by Oblique Double Layers." *J. Geophys. Res.* 89 (1984):2251-66.

127. M. M. MELLOTT and E. W. GREENSTADT. "The Structure of Oblique Subcritical Bow Shocks: ISEE

*Star trails photographed at the Riverside Astronomical Observatory*



*Professor Robert Mutel and his family at the spring picnic*





Professor Edward McCliment

1 and 2 Observations." *J. Geophys. Res.* 89 (1984):2151-61.

128. STANLEY D. SHAWHAN, GERALD B. MURPHY, PETER M. BANKS, P. ROGER WILLIAMSON, and W. JOHN RAITT. "Wave Emissions from DC and Modulated Electron Beams on STS 3." *Radio Science* 19 (1984):471-86.

129. F. L. SCARF., F. V. CORONITI, C. F. KENNEL, R. W. FREDRICKS, D. A. GURNETT, and E. J. SMITH. "ISEE-3 Wave Measurements in the Distant Geomagnetic Tail and Boundary Layer." *Geophys. Res. Lett.* 11 (1984):335-38.

130. C. K. GOERTZ and W.-H. IP. "Limitation of Electrostatic Charging of Dust Particles in a Plasma." *Geophys. Res. Lett.* 11 (1984):349-52.

131. D. R. NICHOLSON. "Parametric Instabilities during Electron Cyclotron Heating of Tandem Mirrors." *Phys. Fluids* 27 (1984):650-57.

132. STEVEN R. SPANGLER and JEAN J. POGGE. "VLA Observations of the Distant Radio Galaxy 3C411." *A. J.* 89 (1984):342-49.

133. JOHN D. FIX and ROBERT L. MUTEL. "Radio and Infrared Observations of Optically Invisible Type II Hydroxyl Masers." *A. J.* 89 (1984):406-10.

134. D. J. DOIRON and R. L. MUTEL. "VLA Observations of the Eclipsing Binary System AR Lacertae." *A. J.* 89 (1984):430-32.

135. G. KNORR and R. L. MERLINO. "The Role of Fast Electrons for the Confinement of Plasma by Magnetic Cusps." *Plasma Physics and Controlled Fusion* 26 (1984):433-42.

136. JOHN T. BAHNS and WILLIAM C. STWALLEY. "Observation of Gain in the Violet Bands of Sodium Vapor." *Appl. Phys. Lett.* 44 (1984):826-28.

137. JEAN-FRANCOIS LESTRADE, ROBERT L. MUTEL, ROBERT A. PRESTON, JOHN A. SCHEID, and ROBERT B. PHILLIPS. "Very Long Baseline Interferometry Observations of the RS Canum Venaticorum System HR 5110." *Astrophys. J.* 279 (1984):184-87.

138. W. T. ZEMKE, R. E. OLSON, K. K. VERMA, W. C. STWALLEY, and B. LIU. "Dipole Moment and Potential Energy Functions of the

$X^1\Sigma^+$  and  $A^1\Sigma^+$  States of NaH." *J. Chem. Phys.* 80 (1984):356-66.

139. C. R. VIDAL and W. C. STWALLEY. "Potential Energy Curves and Adiabatic Corrections of Weakly Bound States: Application to the LiH  $B^1\Pi$  State." *J. Chem. Phys.* 80 (1984):2697-2703.

140. R. L. TOKAR, D. A. GURNETT, and W. C. FELDMAN. "Whistler Mode Turbulence Generated by Electron Beams on Earth's Bow Shock." *J. Geophys. Res.* 89 (1984):105-14.

141. ROBERT L. MERLINO and STEVEN L. CARTIER. "Hysteresis in a Low-Pressure Argon Discharge." *Appl. Phys. Lett.* 44 (1984):33-34.

142. E. F. GABL, J. M. BULSON, and K. E. LONNGREN. "Excitation of a Two-Dimensional Ion-Acoustic Soliton." *Phys. Fluids* 27 (1984):269-72.

143. N. OMIDI, C. S. WU, and D. A. GURNETT. "Generation of Auroral Kilometric and Z Mode Radiation by the Cyclotron Maser Mechanism." *J. Geophys. Res.* 89 (1984):883-95.

144. L. J. CAHILL, M. SUGIURA, N. G. LIN, R. L. ARNOLDY, S. D. SHAWHAN, M. J. ENGBRETSON, and B. G. LEDLEY. "Observation of an Oscillating Magnetic Field Shell at Three Locations." *J. Geophys. Res.* 89 (1984):2735-44.

145. STEVEN L. CARTIER and ROBERT L. MERLINO. "Observations of Nonlinear Behavior in a Low-Pressure Discharge Column." *IEEE Trans. on Plasma Science PS-12* (1984):14-18.

146. W. N. POLYZOU and F. COESTER. "Scattering and Cluster Properties in Relativistic Models of Directly Interacting Confined Quarks." In *Few Body Problems in Physics, Volume II—Contributed Papers*, edited by B. Zeitnitz, 651-52. Elsevier Science Publishers B. V., 1984.

Professor Dwight Nicholson



The University of Iowa does not discriminate in its educational programs and activities on the basis of race, national origin, color, religion, sex, age, or handicap. For additional information on nondiscrimination policies, please contact the Coordinator of Title IX and Section 504 in the Office of Affirmative Action, telephone: (319) 353-4619, 202 Jessup Hall, The University of Iowa, Iowa City, Iowa 52242.

48291/8-84